



CLS-700X  
CLD-700X



10 Additional Color Covers Are Available

WWW.CONCEPTBUY.COM

**OPERATION MANUAL**



338 Turnbull Canyon Road  
City of Industry, CA 91745  
USA

Tel: (626) 968-8827

Fax: (626) 968-9916

Toll Free: (888) 830-1788

www.conceptbuy.com

www.qualitymobilevideo.com

**OSD function**

- 1) Choose the LCD selection by pressing the "SOURCE" button on the remote control.
- 2) Pressing "TFT MENU" key to enter menu below.
- 3) Press [▲] [▼] to select an item.
- 4) Press [◀] [▶] to adjust.
- 5) When the FM transmitter is turned on, there are 8 channels to choose from: 87.7, 88.1, 88.5, 88.9, 106.7, 107.1, 107.5, 107.9. Tune your radio to the corresponding frequency.

**PICTURE**

BRIGHT	75
CONTRAST	25
COLOR	30
TINT	32

**VOLUME**

VOLUME	40
FMSEND	87.7
IRSEND	B

**OPTION**

LANGUAGE	
CALENDAR	
GAME	
SCREEN	L.R.
ZOOM	16:9

**SYSTEM**

S-COLOR	AUTO
---------	------

**CLOCK**

SLEEP TIME	0
OFF-TIME	--:--
ON-TIME	--:--

**CONTENTS**

**CLD-700X**

1. Features	2
2. Front Panel Controls	3
3. Installation	4
4. Remote Control Operation	6
5. System Operation	7
6. Disc Compatibility	8
7. Handling Discs	9
8. Safety Precautions	9
9. Troubleshooting	10
10. Installation	11
11. Leather replacement	12
12. Technical Specifications	13

**CLS-700X**

1. Features	14
2. Warnings	15
3. Product Structure	15
4. Installation	16
5. Leather replacement	17
6. Structure	18
7. Accessories	18
8. Remote control	19
9. OSD function	20

**Features (CLD-700X):**

- High resolution digital panel for superb picture
- Built-in DVD Player compatible with DVD/VCD/MP3/MP4/CD-R/CD-RW/DIVX
- LED backlit panels for exceptional picture quality, high efficiency and long life
- Cover colors easily interchangeable between black, grey and tan to match vehicle interior (all 3 colors included)
- Pole distance adjustable from 4"-7" apart for universal fit
- Free tilt mechanism allows for adjustment to optimal viewing angle
- Mini USB port and SD/MMC card slot for music, image and video files
- Automatically selects PAL/ATSC/ATSC MH system
- Front 3.5 mm jack for headphones
- 2 A/V inputs
  - One 3.5 mm front input jack
  - One wired RCA input
- 1 A/V RCA output
- Wireless remote control
- Built-in dual-channel speaker
- Built-in FM transmitter
- Built-in dual channel IR transmitter
  - Ch A: 2.3MHz(left)-2.8MHz(right)
  - Ch B: 3.2MHz(left)-3.8MHz(right)
- 7" (16:9) TFT LCD display
- Resolution: 800(H) X 480(V)
- Number of Pixels: 336,960
- Brightness: 400 cd/m<sup>2</sup>
- Power supply: DC +12V (10.6V-15.8V)
- Power consumption: 12W
- Operating temperature: -10°C to +60°C
- Dimensions: 11" x 6" x 14 3/4"
- Weight: 3.7 lbs.

**Connection diagram**

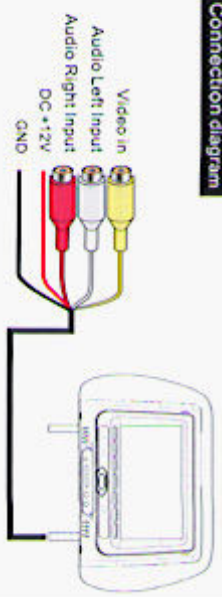

**Remote control**

1. Mute
2. Source selection
3. Direction Buttons
4. Volume
5. LCD AV Select
6. TFT Menu
7. Title Menu
8. Power

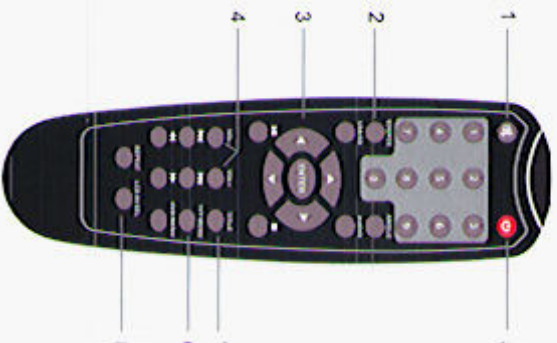

**Structure**

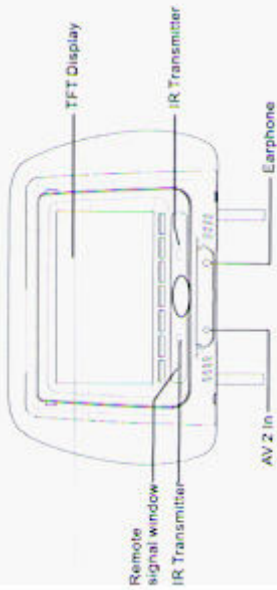

**Front Panel Controls**

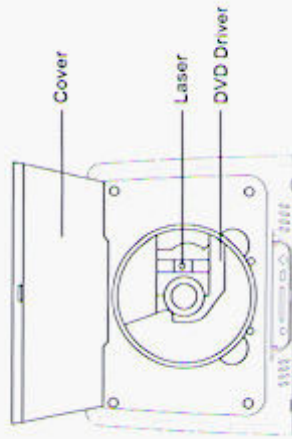
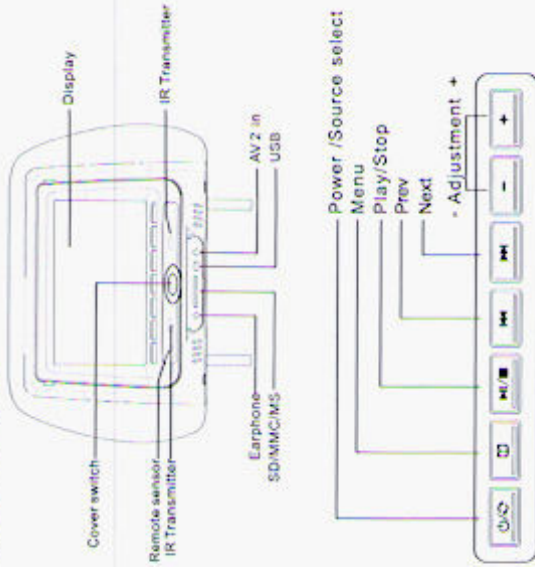

www.qualitymobilevideo.com

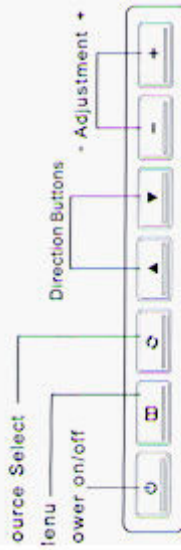

**ACCESSORIES**

Description	Quantity
1. Power Cable	1PC
2. Po/e Diameter Spacers	2PCS
3. Remote Control	1PC
4. Users Manual	1PC
5. Leather	2PC

### Installation

First check to make sure the appearance and installation specifications match with the subject vehicle. Before you begin, choose the right accessories and right tools.

#### Installation steps:

- Step 1. Remove original pillow
- Step 2. Choose the correct installation steel tube size, to ensure proper fit.
- Step 3. Connect the power cord and the Video cable.
- Step 4. Properly position the pillow.



**Note:**  
The appearance and installation specifications are not suited for all vehicles. Please choose the correct appearance and installation specifications.

Connecting Power Line	1
12mm diameter steel tube	2
Remote controller	1
User's manual	1

### Leather replacement

1. Hold down the 2 buttons simultaneously, and removed the screen. Disconnect the cable.

2. Remove the leather.



3. Replace the leather with the matching color cover.



4. Connected the cable, lock the monitor's buttons into position and push it in place to lock.



**Installation**

1. Remove the original pillow in the car.
2. Install the pillow of this monitor. Adjust the steel tube in or out (max. interval: 7 inch; min interval: 4 inch) according to the interval between pillow holes so that the interval between steel tubes of the pillow monitor coincides with that between steel tubes of the original pillow.



3. Forward and back tilt angle adjustment



**Wiring diagram**



The circuit connection of the pillow monitor is very simple, as shown in Fig. Connect the +12V power of the sound system (red line to +, black line to ground), and then connect the video signals.

The headrest DVD player has an AV input port and an output. The input port can connect with other sources such as GPS, TV Box, Game TV-Box etc. The AV output port can connect to other displays.

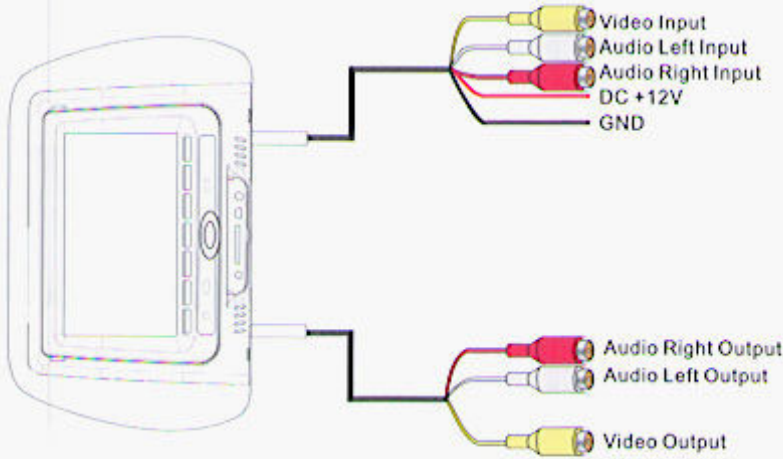

### Remote Control Operation

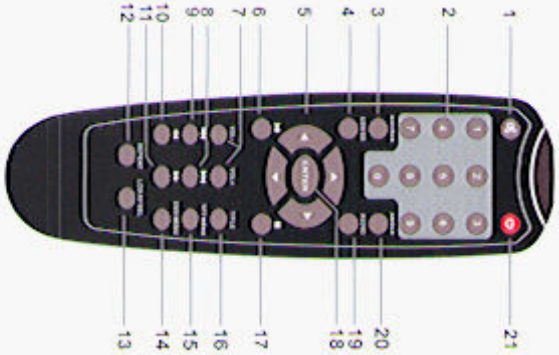

- 1. Mute
- 2. Number selection
- 3. Source selection
- 4. USB/SD/DISC Selection
- 5. Direction Buttons
- 6. Play/Pause
- 7. Volume
- 8,9. Next/Previous
- 10,11. Fast Rewind/Forward
- 12. Repeat selection
- 13. LCD AV Select
- 14. DVD Menu
- 15. TFT Menu
- 16. Title Menu
- 17. Stop
- 18. Enter
- 19. Audio
- 20. Angle
- 21. Power

www.qualitymobilevideo.com

**Warning**

- ▶ Read this manual before using this product.
- ▶ This product is composed of precision components and shall not be disassembled unless approved or authorized by us, otherwise you will void your warranty
- ▶ Protect the product from moisture and shock



### Product structure

" Thank you for your purchase of our mobile video product. To ensure long-term trouble free operation of the product, please read the following operations manual before using the monitor. To further ensure the long-term service of your product, please have one of our authorized dealers to install this product into your vehicle for you. "

**Features (CLS-700X):**

- High resolution digital panel for superb picture
- LED backlit panels for exceptional picture quality, high efficiency and long life
- Cover colors easily interchangeable between black, grey and tan to match vehicle interior (all 3 colors included)
- Pole tilt adjustable from 4°-7° apart for universal fit
- Free tilt mechanism allows for adjustment to optimal viewing angle
- Automatically selects PAL/ATSC/ATSC MH system
- Built-in front 3.5mm AV input jack
- Front 3.5mm jack for headphones
- 2 AV inputs
- One 3.5mm front input jack
- One wired RCA input
- Wireless remote control
- Built-in dual-channel speaker
- Built-in dual channel IR transmitter
- Ch A: 2.3MHz(left)-2.8MHz(right)
- Ch B: 3.2MHz(left)-3.8MHz(right)
- 7" (16:9) TFT LCD display
- Resolution: 800(H) X 480(W)
- Number of Pixels: 336,960
- Brightness: 400 cd/m2
- Power supply: DC +12V (10.6V-15.8V)
- Power consumption: 12W
- Operating temperature:-10°C to +60°C
- Dimensions: 11" x 6" x 14 3/4"
- Weight: 2.9 lbs.

**System Operation**

- 1) Choose the LCD selection by pressing the "SOURCE" button on the remote control.
- 2) Pressing "TFT MENU" key to enter menu below .
- 3) Press [▲] [▼] to select an item.
- 4) Press [◀] [▶] to adjust.
- 5) When the FM transmitter is turned on, there are 8 channels to choose From: 87.7, 88.1, 88.5, 88.9, 106.7, 107.1, 107.5, 107.9. Tune your radio to the corresponding frequency.

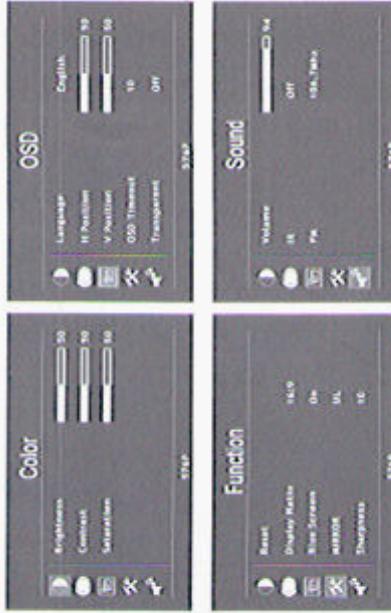

### Disc Compatibility

Disc type	DVD video	Video CD	Audio CD
Disc format	DVD	VCD	CD
Contents	Audio+ Video	Audio+ Video	Audio
Disc type	Disc size	Maximum playing time	
Disc type	5 inches (12cm)	Approx. 133 minutes(SS/SL) Approx. 242 minutes(SS/DL) Approx. 266 minutes(DS/SL) Approx. 484 minutes(DS/DL) *SS:Single Sided ,DS:Double Sided, SL:Single Layer ,DL :Dual Layer	
Video CD	5 inches (12cm)	Approx. 74 minutes	
Audio CD	5 inches (12cm)	Approx. 74 minutes	
CD-ROM	5 inches (12cm)	MP3 : music file WAV: music file MPG: motion picture file VOB: DVD file JPG: picture file	

### Handling Discs

- Dust particles, scratches or twisting may cause sound disruption, poor sound quality or poor screen image during play.
- Use a soft cloth to gently clean fingerprints and dust on the data surface (polished side) of the disc
  - Never use anti-static spray or liquid benzene, thinner or other chemical solvents to clean discs. Such chemical solvents may damage the plastic surface of the disc.
  - After playing discs, you are advised to place them inside their original cases to prevent any damage to them.
  - Do not expose discs to direct sunlight, high humidity or high temperatures for long periods of time. Discs may deform.
  - Do not write on the disc's signal surface. A sharp pen or ink may cause damage to the surface of the disc.
  - The sound quality may vary among discs depending on their recording methods.

### Technical Specifications

Panel	TFT LCD
Screen Size	7 inches (16:9)
Pixel	800×3(RGB)×480
Temperature	Operation:14 °F – 122 °F; Storage:-22 °F – 167 °F
Back light	LED
Brightness	400 cd/m <sup>2</sup>
Color system	PAL/NTSC
Disc Formats	DVD, VCD, CD, MP3, CD-R, CD-RM, DVD-R, DVD-RM, VCD
Resolution	≥500
S/N	≥90 dB
Isolation	≥65 dB
Audio Input/Output	1.6V±20%
Video Input/Output	1V p-p ±20%
Power Supply	DC 12V
Power	≤ 12W
Product Dimensions	11" x 6" x 14 %
Net Weight	3.7 lbs

**Note:**  
The design and specifications are subject to change without notice.

**leather replacement**

1. Hold down the 2 buttons simultaneously, and removed the screen. Disconnect the cable.



2. Remove the leather.



3. Replace the leather with the matching color cover.



4. Connected the cable, lock the monitor's buttons into position and push it in place to lock.



**Safety Precautions**

- This device is designed to be operated with a DC 12V grounded system.
- Do not allow any foreign substance to get into the disc slot.
- The device may not work in high or low temperatures. Stop using the device until the temperature returns to a normal level. Operating temperature range: 14°F--122°F)

**Cleaning**

- When cleaning the device, do not make contact with water. The device may get damaged.
- Since chemical solvents may damage the surface of the unit, do not use them for cleaning.
- Use a clean and dry cloth to clean.

**Condensation**

- When turning the heater on in the car during a rainy or humid day, moisture may condense on the optical lens. If this occurs, the device may not read the disc and will not function properly. In such a case, it is advised to remove the disc from the device until the unit is dried.

**Installation and Repairs**

- Please install and operate the device as specified by this manual. If you cannot install the device correctly yourself, take it to an authorized dealer.
- Do not open the device by yourself for repairs. If the device does not work properly, take it to an authorized dealer. (If you disassemble the unit, you will void the warranty).

**Video/Audio Trouble**

- When driving on a rough road the unit is prone to severe shaking and may experience video/audio problems. This is inevitable.

### Troubleshooting

Fault	Reason	Resolution
No power	Yellow wire should be connected to 12v + source; red wire should be connected to the ACC; black wire should be connected to the ground	Connect power correctly
	Fuse burned out	Change fuse
No picture	Power cable is disconnected	Connect power correctly
	No AV input	Check input video
Remote does not work	Video lines disconnected	Reconnect video lines
	Battery is blocked by protective paper	Remove paper
	Pointed in wrong direction	Point remote to remote sensor
Can't play Disc	No power	Change batteries
	Bad disc	Replace disc
Distortion	Disc loaded incorrectly	Re-insert disc
	Disc is dirty	Clean disc
	Fast forward/backward	This is normal

### Installation

1. Remove the original pillow in the car.
2. Install the pillow of this monitor. Adjust the steel tube in or out (max. interval: 7inch;min interval:4 inch) according to the interval between pillow holes so that the interval between steel tubes of the pillow monitor coincides with that between steel tubes of the original pillow.



3. Forward and back tilt angle adjustment



4. Wiring diagram

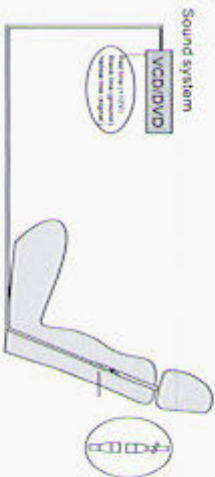

The circuit connection of the pillow monitor is very simple. As shown in Fig. Connect the +12V power of the sound system(red line to +,black line to ground),and then connect the video signals.

### Remote Control Operation

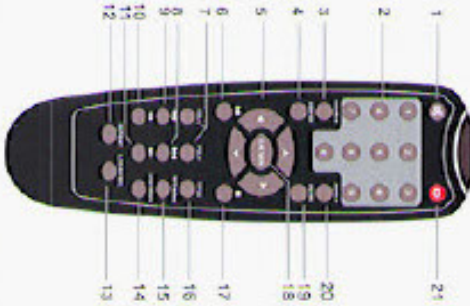

- 1 Mute
- 2 Number selection
- 3 Source selection
- 4 LCD/SD/ID/ISC Selection
- 5 Direction buttons
- 6 Play/Pause
- 7 Volume
- 8,9 Mute/Previous
- 10,11 First Selection/Forward
- 12 Repeat selection
- 13 LCD/AV Select
- 14 DVD Menu
- 15 TTT Menu
- 16 Title Menu
- 17 Stop
- 18 Enter
- 19 Audio
- 20 Angle
- 21 Power

www.qualitymobilevideo.com

**Warning**

- ▶ Read this manual before using this product.
- ▶ This product is composed of precision components and shall not be disassembled unless approved or authorized by us, otherwise you will void your warranty.
- ▶ Protect the product from moisture and shock.



**Product structure**

... Thank you for your purchase of our mobile video product. To ensure long-term trouble free operation of the product, please read the following operations manual before using the monitor. To further ensure the long-term service of your product, please have one of our authorized dealers to install this product into your vehicle for you.